

Figure 1: Parallel block

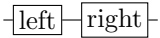

Figure 2: Series block

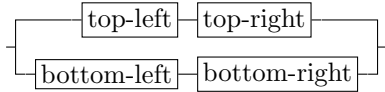

Figure 3: Series blocks in parallel

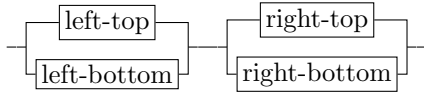

Figure 4: Parallel blocks in series



Figure 5: Series blocks in series

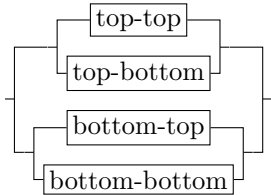

Figure 6: Parallel blocks in Parallel

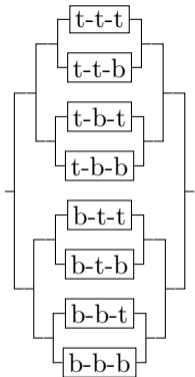

Figure 7: Parallel blocks in parallel, in parallel

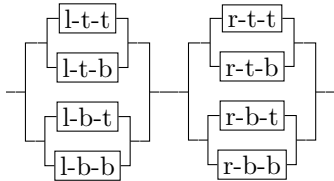

Figure 8: Parallel blocks in parallel, in series



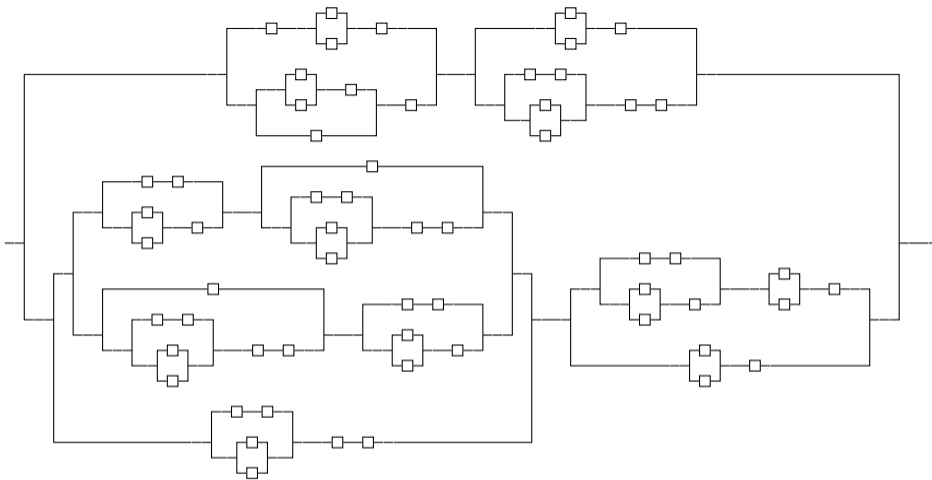

Figure 9: This example shows latex macros which nest tikz environments together to generate series and parallel graph diagrams. This shows an example of latex-macros and nesting of tikz environments being used to draw large recursively-defined (nested) diagrams.